

BEST 400

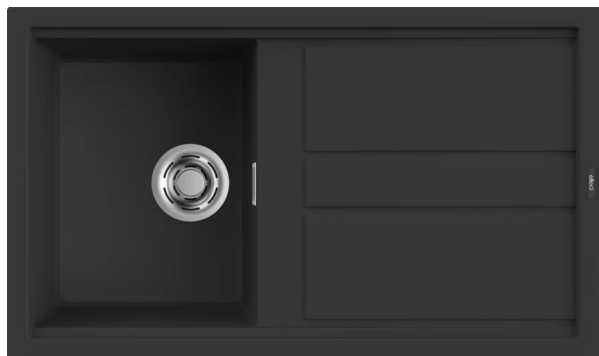

Méretrajz

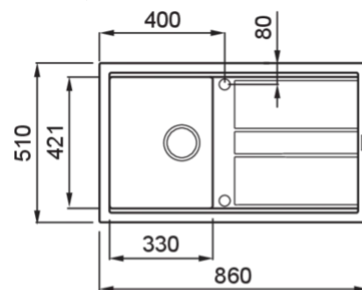

0	
Jelleg	1 medence csepegtetővel
Modell	BEST 400
Székrenyméret (mm)	450
Béépíthetőség	munkalapra szerelhető
Méret (mm)	860 x 510
Kivágási méret (mm)	840 x 480
Medence mélység (mm)	200



KERATEK[®] plus

CERAMIC NANOTECHNOLOGY CN6



LKB40086 K86
8031873020057



LKB40093 K93
8031873026479



LKB40095 K95
8031873026486



LKB40096 K96
8031873020064



LKB40097 K97
8031873026493



LKB40099 K99
8031873026509

GRANITEK[®]

NATURAL GRANITE EFFECT

METAL



LMB40073 M73
8032861953708



LMB40079 M79
8032861953715

MATT



LGB40040 G40
8032861047896



LGB40043 G43
8032861040897



LGB40048 G48
8032557030553



LGB40068 G68
8032861040873

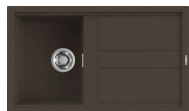

LGB40078 G78
8032557066910

CLASSIC



LGB40051 G51
8032861040750



LGB40059 G59
8032861047889



LGB40062 G62
8032861040743

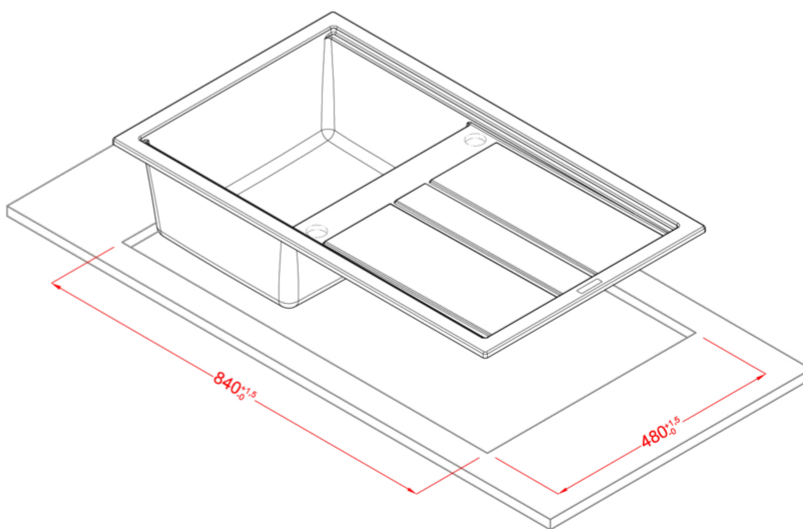
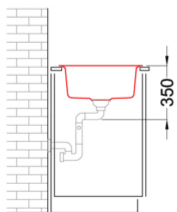
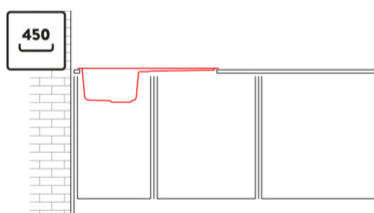
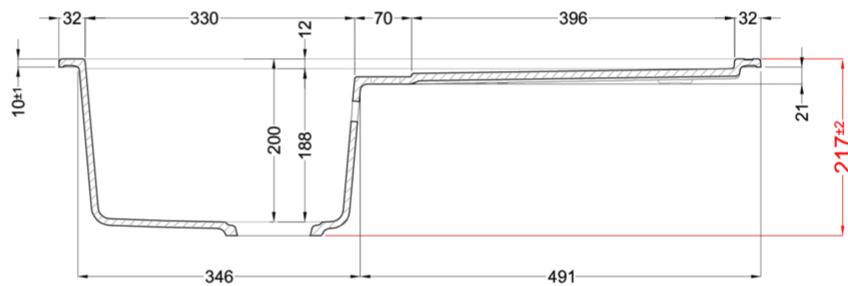
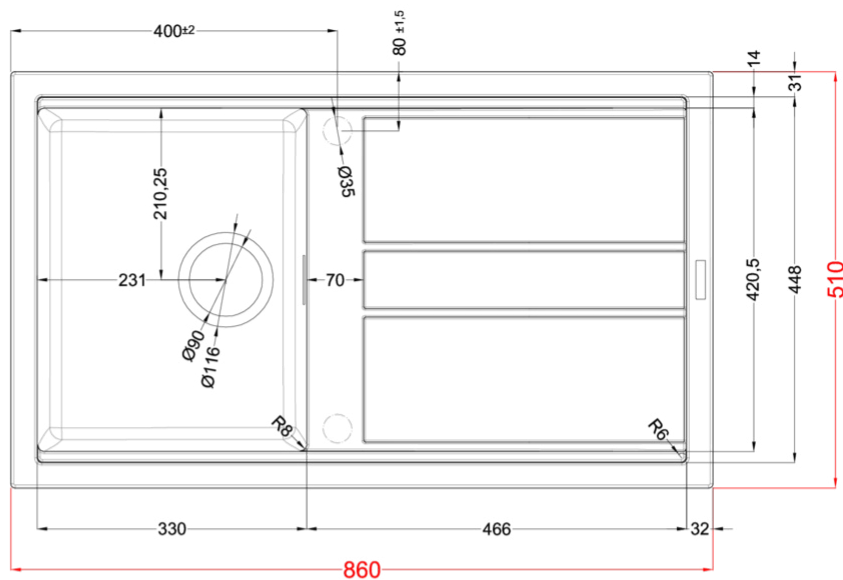
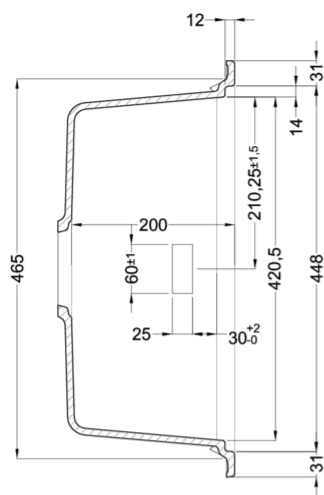

BEST 400

general tolerances where not expressly communicated $\pm 0.2\%$
connection dimensions according to UNI EN 695

