

# BEST 450 MUNKALAP ALÁ

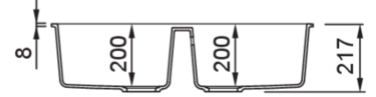

Méretrajz

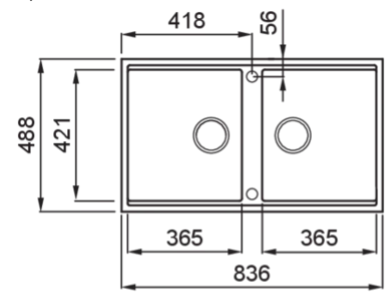

JELLEG	2 medence
MODELL	BEST 450 munkalap alá
SZEKRÉNYMÉRET (mm)	900
BEÉPÍTHETŐSÉG	Munkalap alá szerelhető
MOSOGATÓTÁLCA MÉRETEI (mm)	836 x 488
KIVÁGÁSI MÉRETEK (mm)	795 x 448 R6
MEDENCÉK SZÁMA	2



## KERATEK



**LKB45086BSO** K86  
8031873020149



**LKB45093BSO** K93  
8031873026523



**LKB45095BSO** K95  
8031873026530



**LKB45096BSO** K96  
8031873020163



**LKB45097BSO** K97  
8031873026554



**LKB45099BSO** K99  
8031873026578

## GRANITEK

METAL



**LMB45073BSO** M73  
8032861953739



**LMB45079BSO** M79  
8032861953753

# GRANITEK

## MATT



**LGB45040BSO** G40  
8032861047872



**LGB45043BSO** G43  
8032861043423



**LGB45048BSO** G48  
8032557030843



**LGB45068BSO** G68  
8032861043614



**LGB45078BSO** G78  
8032557066934

# GRANITEK

## CLASSIC



**LGB45051BSO** G51  
8032861041658



**LGB45059BSO** G59  
8032861042792



**LGB45062BSO** G62  
8032861046998

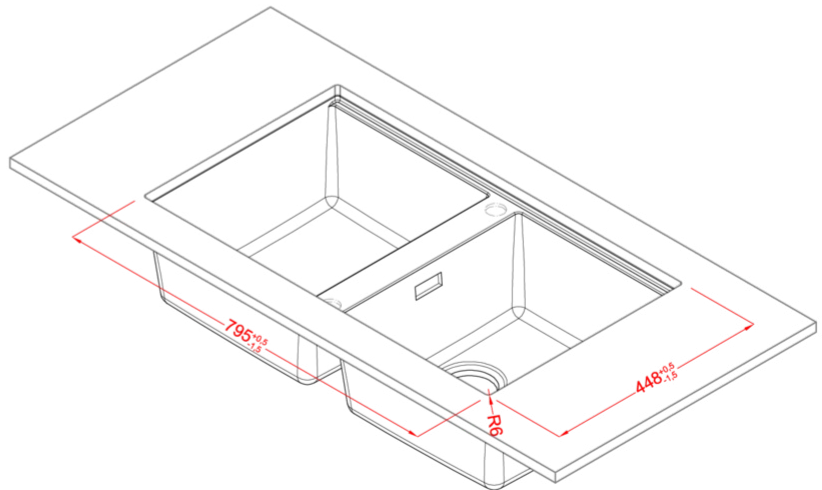
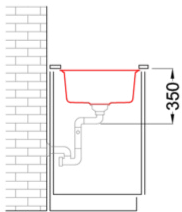
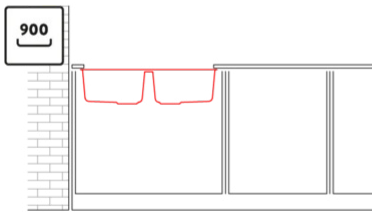
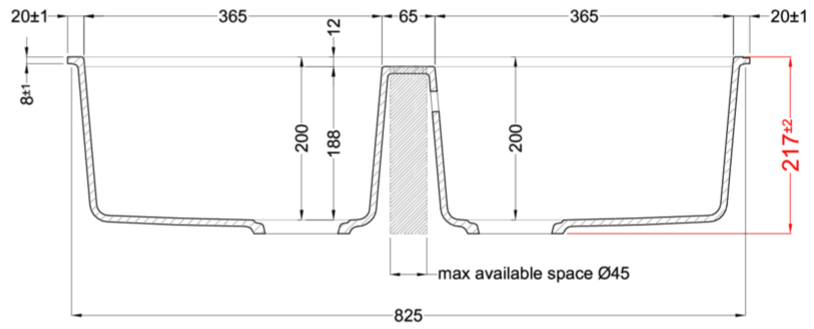
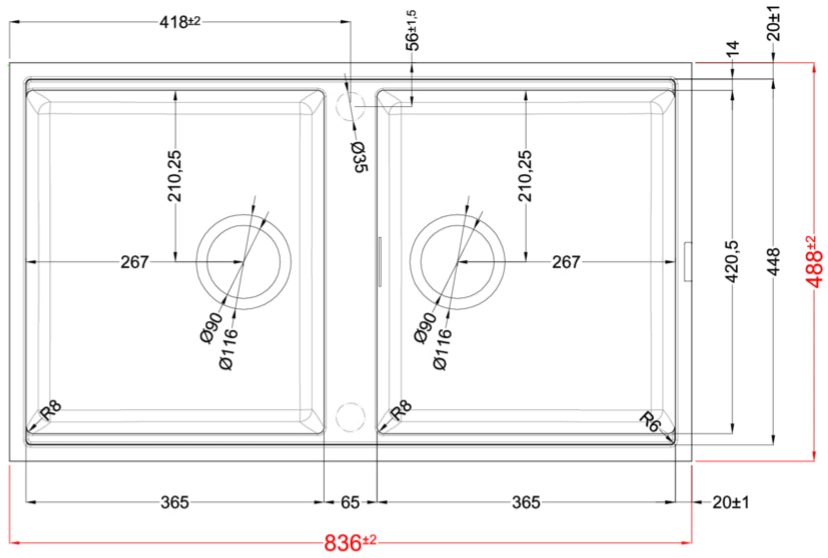
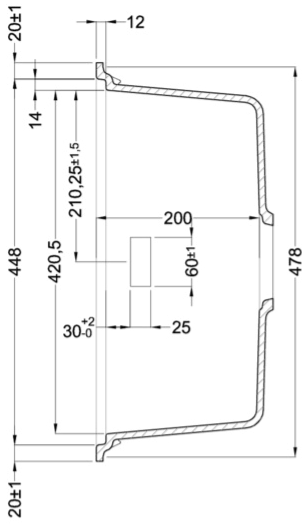

## BEST 450 UNDERMOUNT

general tolerances where not expressly communicated  $\pm 0.2\%$   
connection dimensions according to UNI EN 695

