

QUADRA 110

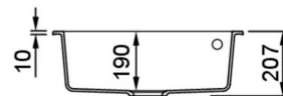

Méretrajz

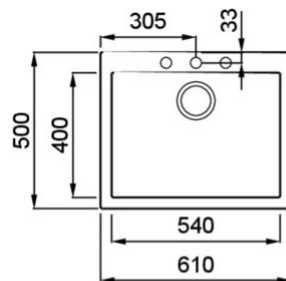

Jelleg	1 medencés
Modell	QUADRA 110
Székrenyméret (mm)	600 800 ha a mosogató kezdőelem munkalapra szerelhető
Mosogató mérete (mm)	610 x 500
Kivágási méret (mm)	590 x 480
Medence mélység (mm)	190

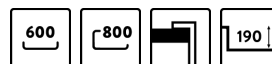

KERATEK^{plus}
CERAMIC NANOTECHNOLOGY CN6

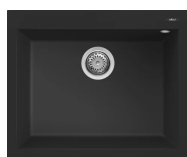

LKQ11086 K86
8031873020583



LKQ11093 K93
8031873027315



LKQ11095 K95
8031873026004



LKQ11096 K96
8031873020576



LKQ11097 K97
8031873027339



LKQ11099 K99
8031873027353

METAL

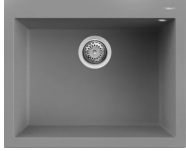

LMQ11073 M73
8032861955429



LMQ11079 M79
8032557952916

MATT



LGQ11040 G40
8032557046165



LGQ11043 G43
8032861041740



LGQ11048 G48
8032557043645



LGQ11068 G68
8032861055389

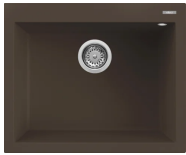

LGQ11078 G78
8032557067153

CLASSIC



LGQ11051 G51
8032861055310



LGQ11059 G59
8032861055365



LGQ11062 G62
8032861055372

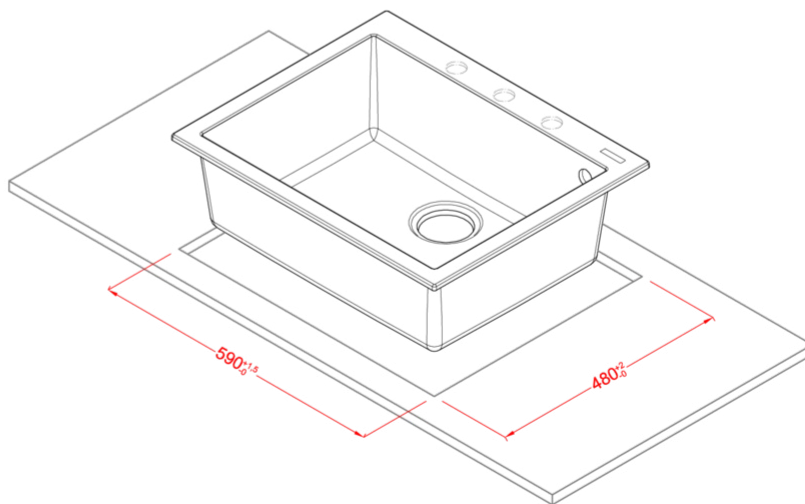
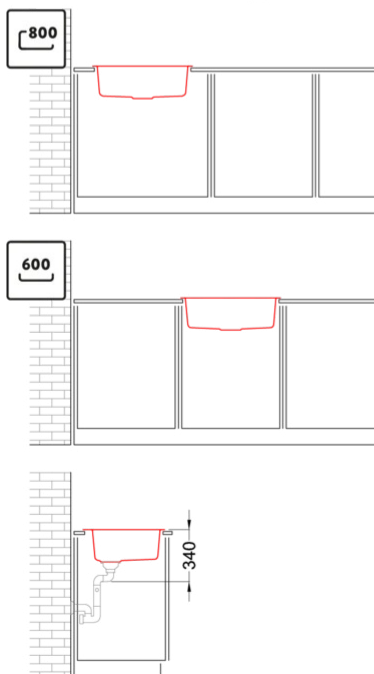
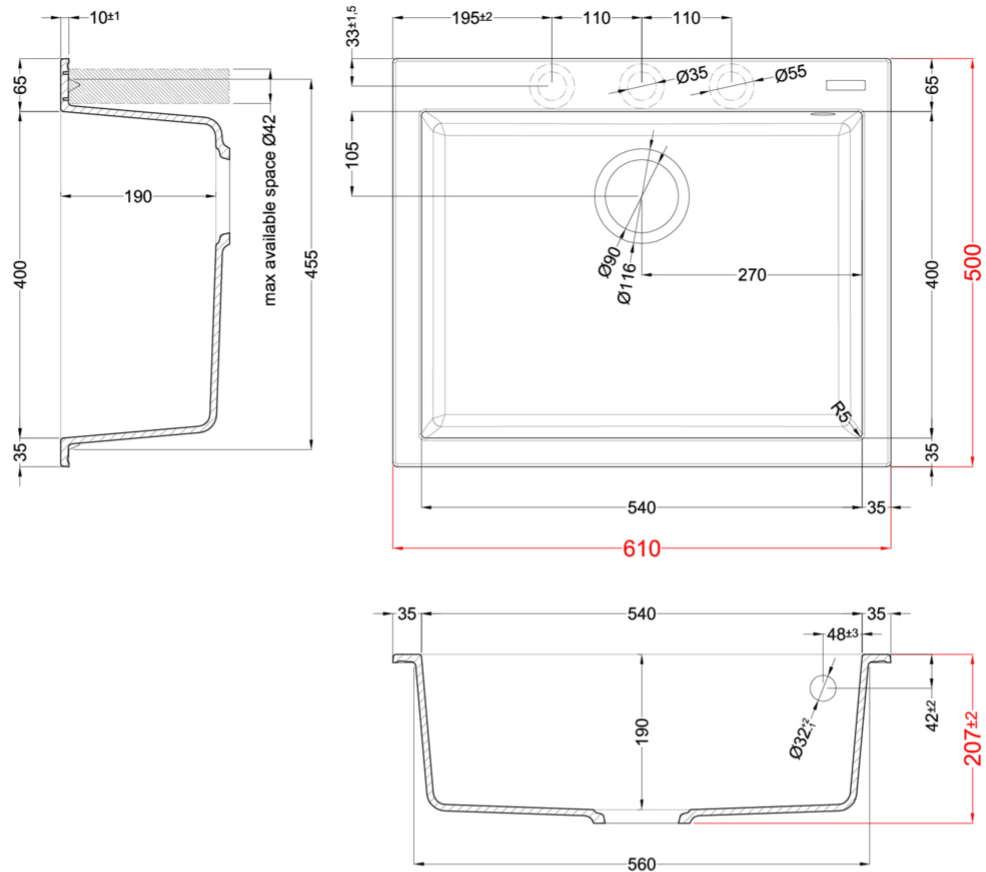

QUADRA 110

general tolerances where not expressly communicated ±0.2%
connection dimensions according to UNI EN 695

