

# QUADRA 130

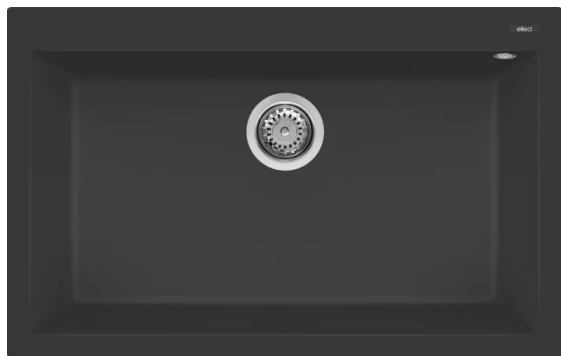

Méretrajz

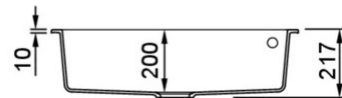
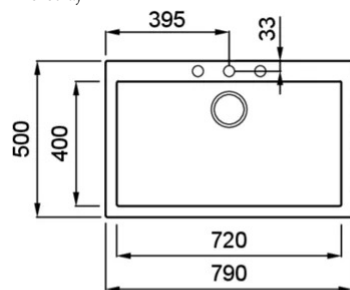

0

Jelleg	1 medencés
Modell	QUADRA 130
Székrenyméret (mm)	800
Béépíthetőség	Munkalapra szerelhető
Méret (mm)	790 x 500
Kivágási méret (mm)	770 x 480
Medence mélység (mm)	200



## KERATEK<sup>plus</sup>

CERAMIC NANOTECHNOLOGY CN6

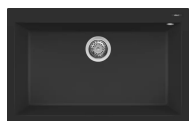

**LKQ13086** K86  
8031873020538

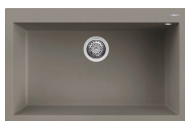

**LKQ13093** K93  
8031873027377

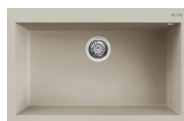

**LKQ13095** K95  
8031873025878



**LKQ13096** K96  
8031873020521



**LKQ13097** K97  
8031873027391



**LKQ13099** K99  
8031873027414

## GRANITEK<sup>®</sup>

NATURAL GRANITE EFFECT

METAL



**LMQ13073** M73  
8032861955610



**LMQ13079** M79  
8032557952909

MATT

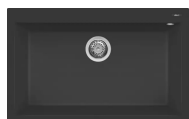

**LGQ13040** G40  
8032557049548

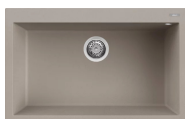

**LGQ13043** G43  
8032861041795



**LGQ13048** G48  
8032557033455



**LGQ13068** G68  
8032861055570

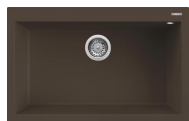

**LGQ13078** G78  
8032557067177

CLASSIC



**LGQ13051** G51  
8032861055501

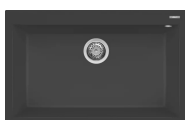

**LGQ13059** G59  
8032861055556

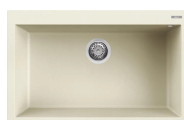

**LGQ13062** G62  
8032861055563

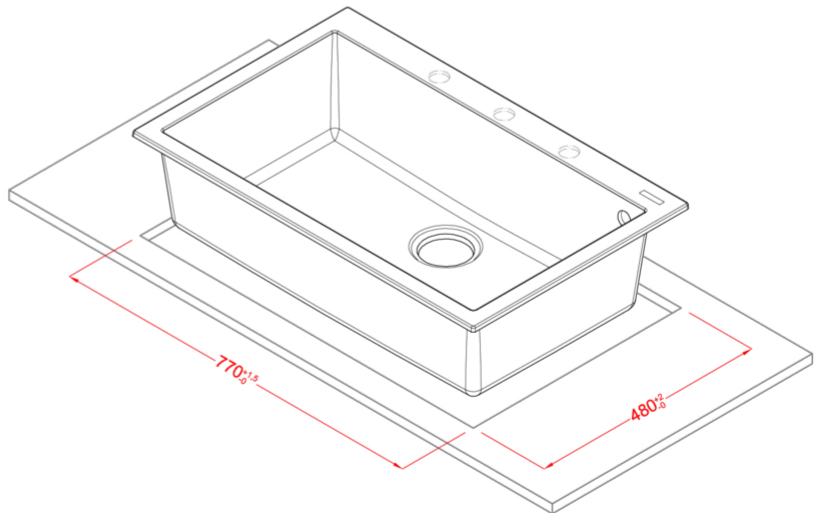
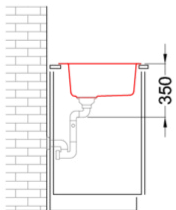
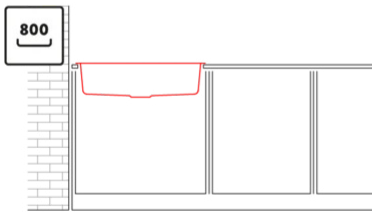
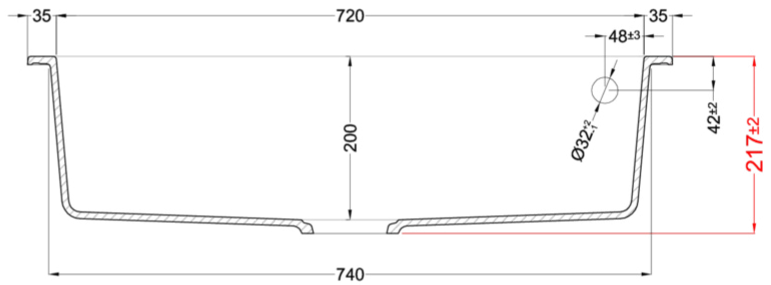
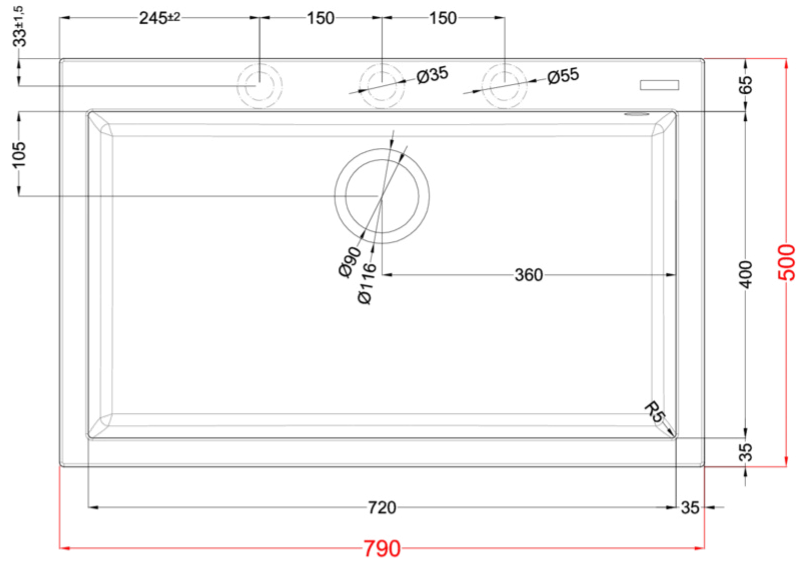
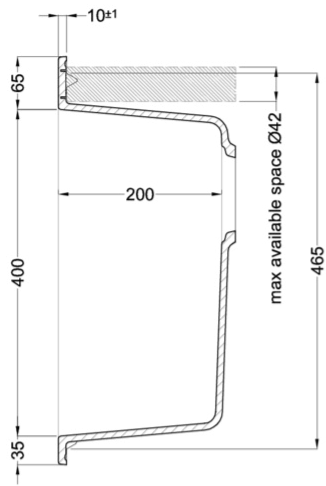

## QUADRA 130

general tolerances where not expressly communicated  $\pm 0.2\%$   
connection dimensions according to UNI EN 695

